

Article number: 0105051  
 Description: Retaining ring AV 34  
 Note: Fitted with ZGA pliers

## Measures

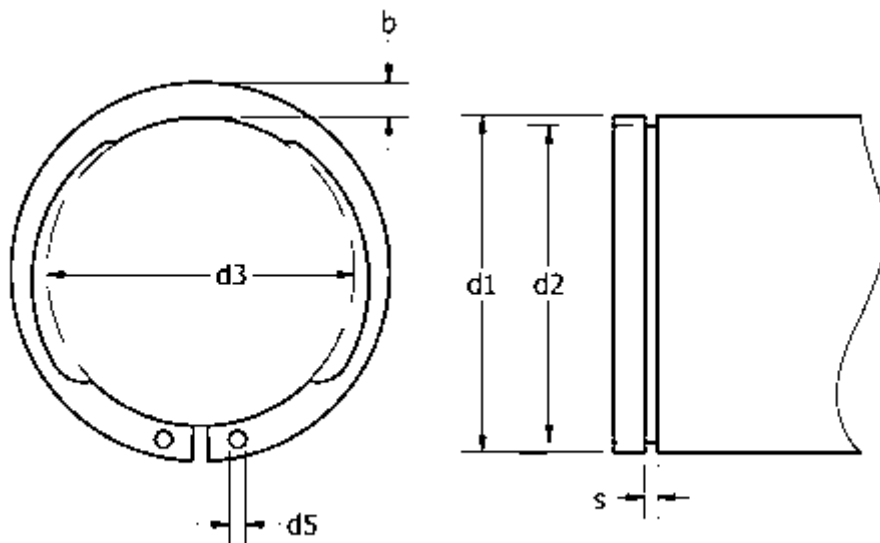

AN mm <sup>2</sup>	= 40.0	FRg kN	= 4.6	t	= 0.85
b	= 3.5	FR kN	= 26.6	tol	= -0.06
d1	= 34	g	= 2.0	tol	= -0.25
d2	= 32.3	K kN-mm	= 50.5	tol	= +0,25-0,50
d3	= 31.50	m min	= 1.60	tol	= 0.1
d5 min	= 2.0	n abl x 1000	= 15	Tong	= ZGA-2
Description	= AV 34	s	= 1.50	Weight kg/1000	= 3.60
FN kN	= 6.67	Side power N at I2	= 2.5		